



TRIGEN[◇]

Hindfoot Fusion Nail Surgical Technique

As described by:

Thomas A. Russell, MD

Roy W. Sanders, MD

John S. Early, MD

Contents

Design rationale	3
Indications	3
Design features	4
Design specifications	5
Surgical Technique	6
Catalog information	19

Nota Bene

The technique description herein is made available to the healthcare professional to illustrate the author's suggested treatment for the uncomplicated procedure. In the final analysis, the preferred treatment is that which addresses the needs of the specific patient.

Uncover an easier and more advanced nailing system

The TRIGEN® Hindfoot Fusion Nail (HFN) offers unique locking configurations allowing the surgeon to target the best bone possible within the hindfoot to maximize purchase and position. As an addition to the already successful TRIGEN Intramedullary Nail System, the TRIGEN HFN uses the simplified instrumentation that has made TRIGEN a standout among other systems.



Design rationale

The TRIGEN® Hindfoot Fusion Nail (HFN) brings the simplified instrumentation of the TRIGEN Nail System to the hindfoot. The TRIGEN HFN features an oblique locking configuration that allows surgeons to maximize thread purchase by locking into better bone. The TRIGEN HFN advantage allows surgeons to target screws through the calcaneus and into specific bones to attain the most stable construct while at the same time gaining fusion between the calcaneus and surrounding bones. Fusion is further aided by allowing screws to cross the articulating surfaces of the calcaneus and talus, as well as the calcaneus and cuboid bones.

Unlike other ankle arthrodesis nails that are currently available in the market, the TRIGEN HFN offers threaded distal screw holes for added stability and reduced risk of screw back out. In addition, the surgeon may select not to use specific holes or to use shorter screws that allow the joints to maintain mobility. Rotational stability is also achieved by either a proximal static locking hole or dynamic compression slot in the proximal end of the nail. The region of the nail near the driven end (inferior when implanted) has an increased outer diameter for additional rigidity and stability.

Indications

The TRIGEN HFN is indicated for degeneration, deformity, or trauma of both the tibiotalar and talocalcaneal articulations in the hindfoot; tibiocalcaneal arthrodesis; combined arthrodesis of the ankle and subtalar joints; avascular necrosis of the ankle and subtalar joints; failed total ankle replacement with subtalar intrusion; failed ankle arthrodesis with insufficient talar body; rheumatoid arthritis; severe deformity secondary to untreated talipes equinovarus or neuromuscular disease; and severe pilon fractures with trauma to the subtalar joints.

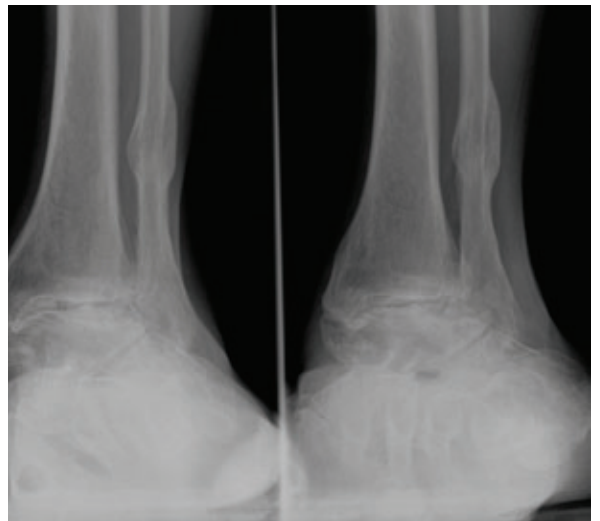
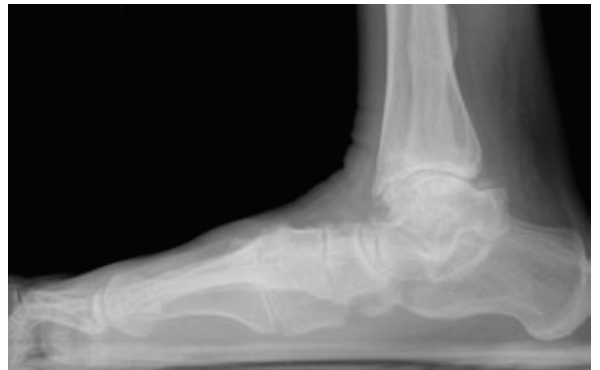

Design features

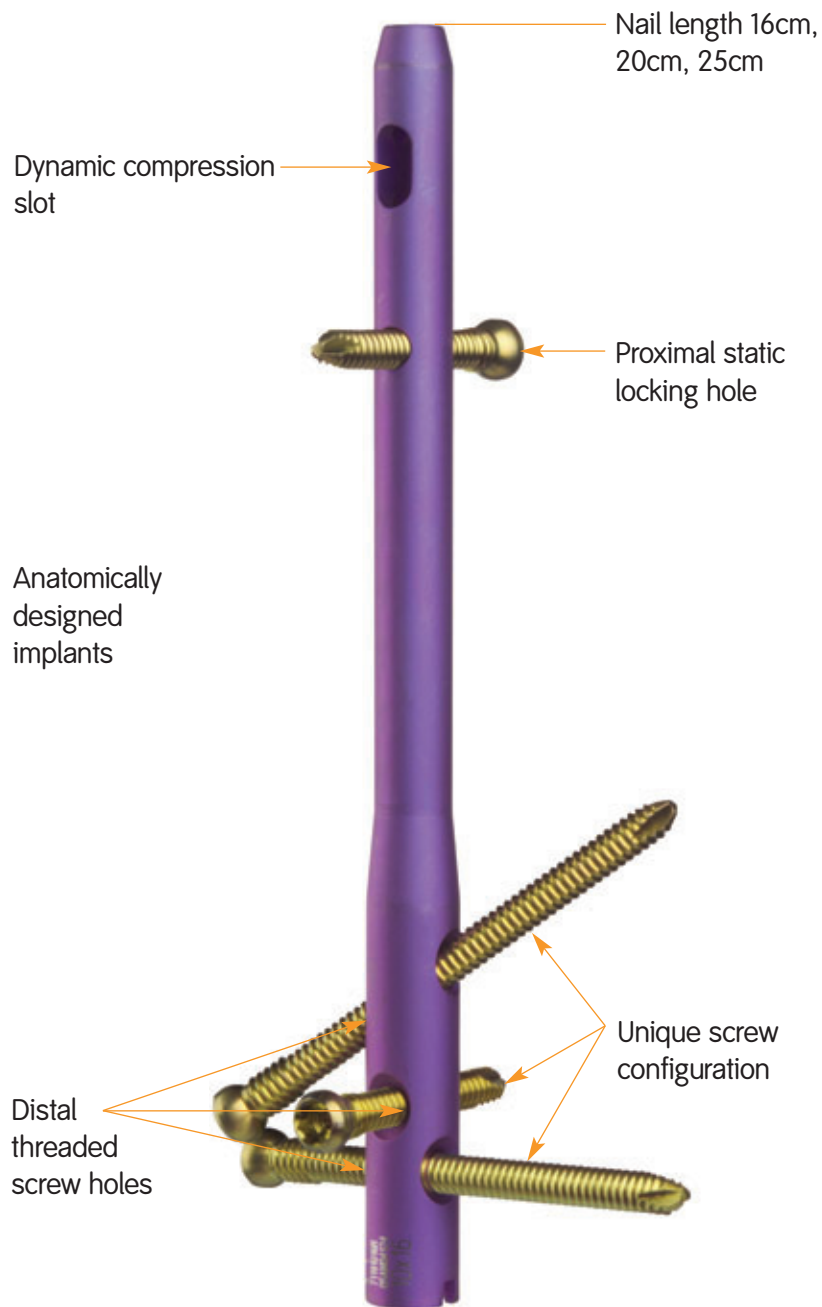

Advantages

- Simplified instrumentation and anatomically designed implants included as part of the TRIGEN® line
- Diverging screw angles allow the surgeon to target specific bones and joints
- Distal threaded screw holes help to reduce risk of screw back out while adding stability
- Various screw sizes give the surgeon more options for patient care
- Rotational stability achieved with proximal static locking hole or dynamic compression slot
- Dynamic compression slot allows up to 5mm of late controlled compression
- Internal hex captured locking screws help to ease screw insertion

Design specifications

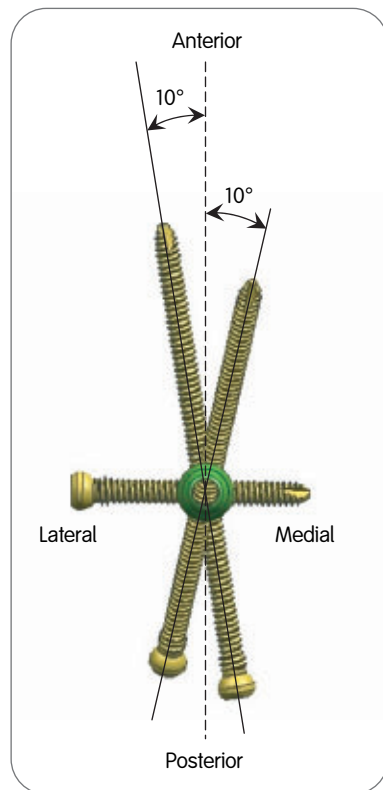
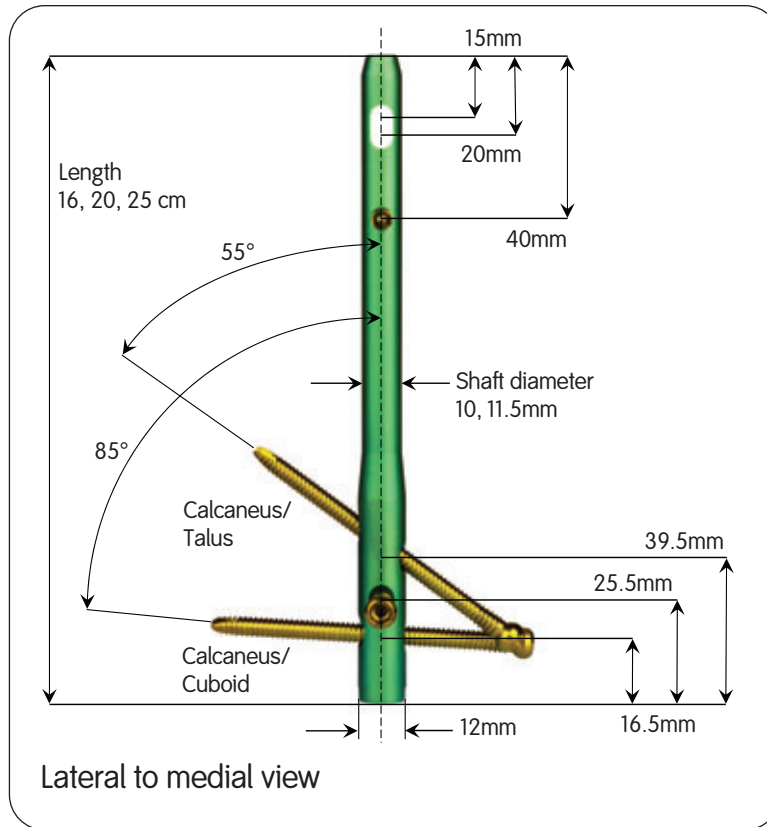

NOTE: These views are not to scale and should be used as a pictorial representation only.

Specifications	TRIGEN® HFN
Material	Ti6AL4V
Diameter	10.0, 11.5mm
Lengths	16, 20, 25cm
Nail color	Left - Lime Right - Rose
Cross Section	Round
Distal Diameter (driving end)	12mm
Proximal Diameter (non-driving end)	10.0 and 11.5mm
Smallest Thru Diameter	5.4mm
Wall Thickness	4.6mm (10 Dial), 6.1mm (11.5 Dial)
Guide Bolt Thread	5/16 - 24
Alternative Guide Bolts	RT Tibial, Retrograde, IMSC, Revision
Alternative Modes	No
Major Screw Diameter	5.0mm
Minor Screw Diameter	4.3mm
Hex Size	4.7mm
Alternative Hex Drivers	RT Femoral & Recon, 7.0mm Cannulated Screw, PERI-LOC® Locking Screw Guide
Screw Color	Gold
Screw Lengths	25-110mm
AP Bow	No bow
Location of Distal Bend	No bow
Distal Locking (Driving End)	
Location	16.5, 25.5, 39.5mm
Distal Dynamization Slot	none
Distal Screw Hole Diameter	5.3mm
Orientation	Calcaneus/Talus P-A oriented and 55 degrees from nail axis in M-L plane, and 10 degrees off axis in sagittal plane. Calcaneus/Cuboid P-A oriented and 85 degrees from nail axis in M-L plane, and 10 degrees off axis in sagittal plane. Transverse L-M oriented with no angulation.
Proximal Locking (Non-Driving End)	
Proximal Screw Hole Diameter	5.3mm
Screw Hole Locations	15-20mm, 40mm
Orientation	M-L
Proximal Dynamization Slot	Yes

Surgical technique

Preoperative Planning

The appropriate TRIGEN[®] HFN implant length and diameter can be determined using the preoperative X-ray template.

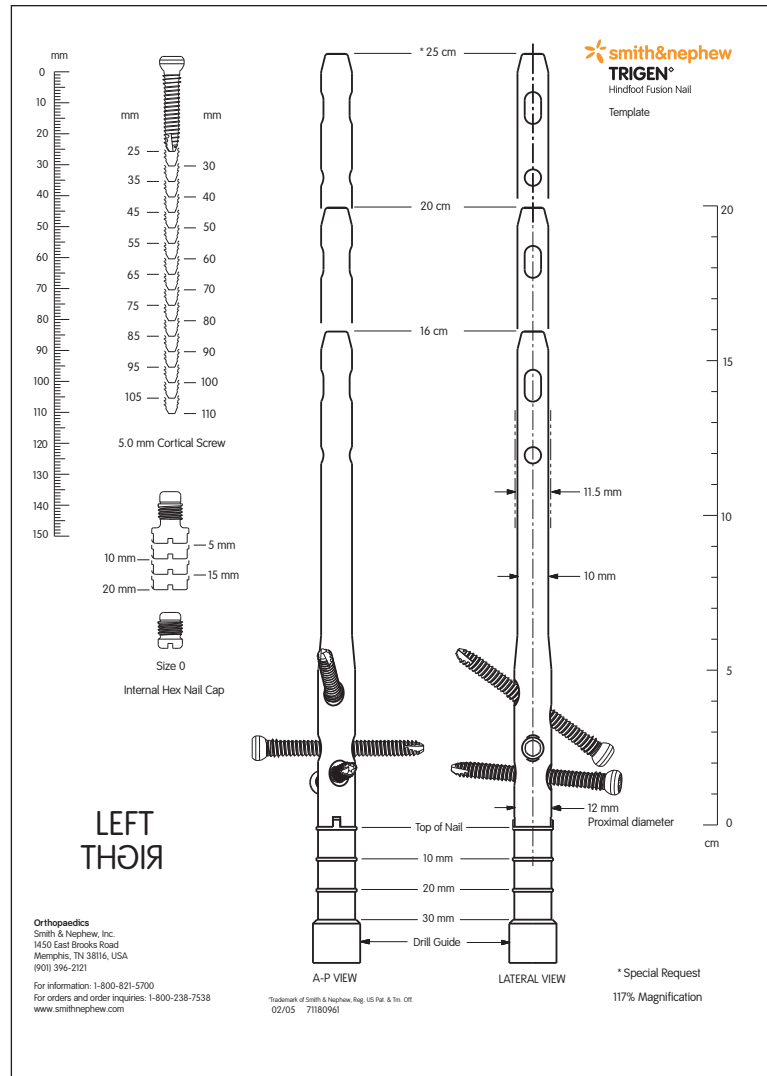

TRIGEN HFN X-ray Template

Cat. No. 7118-0961

Patient positioning

The prone position is preferred, but lateral and supine positions are acceptable if needed. Patient positioning is determined based on the type of arthrodesis procedure performed and is therefore at the surgeon's discretion.

C-Arm position

The C-arm should come in perpendicular to the leg, on the opposite side of the operating table. In the standard position this will provide an AP (supine), PA (prone), or lateral (lateral) radiograph. Turning the C-arm 90 degrees will afford a lateral view for the supine and prone positions while providing an AP view for the patient in the lateral position.

Note: For optimal viewing, the operating table should be radio translucent.

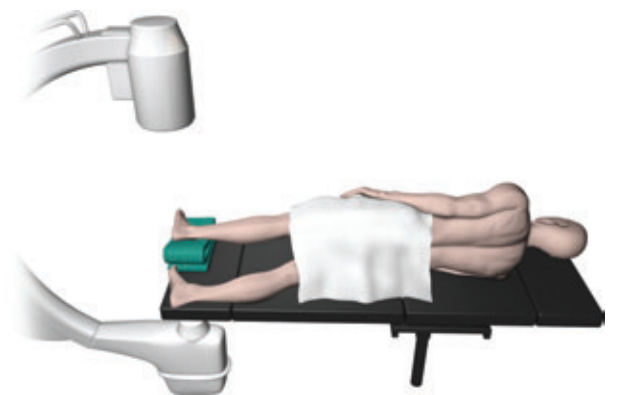
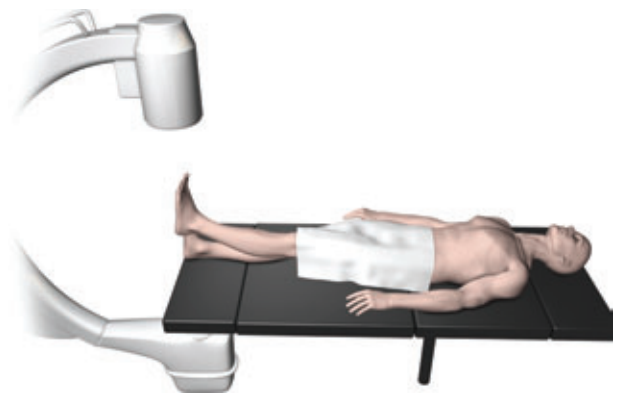
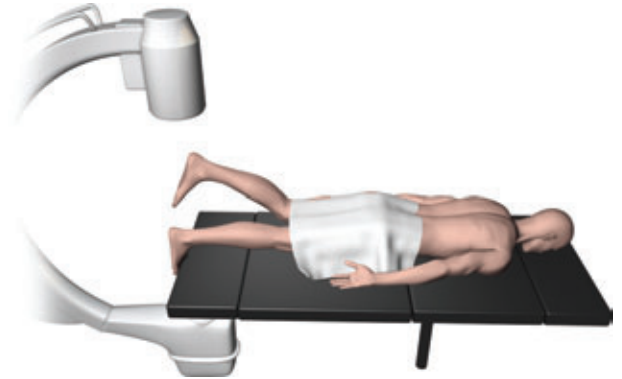

Surgical approach

The approach chosen for the debridement, preparation and alignment of the hindfoot joint surfaces is based on factors such as surgical preference, patient positioning, and anatomy. The simplest approach is usually through a lateral incision over the fibula and into the sinus tarsi. Full access to the joint surfaces requires a fibular osteotomy above the tibiotalar joint. This allows direct visualization and access to both the tibiotalar and sub-talar joints for debridement and subsequent alignment for fixation. This approach can be extended distally if access to the calcaneocuboid joint is needed.

Entry portal

Once all the joint surfaces have been prepared and aligned in the desired position of fusion, the C-arm is brought into position laterally, and the 3.2mm x 343mm Brad Point Tip Threaded Guide Pin is placed on the plantar surface of the foot in line with the tibia, talus, and calcaneus. The use of provisional guide pin fixation to maintain correct position of the respective arthrodesis is recommended. The Guide Pin will start slightly lateral to midline, in line with the tibial medullary canal axis.

Using this as the center of the planned insertion point, a 3cm longitudinal incision is made on the plantar aspect of the heel.



A hemostat is used to bluntly spread the soft tissues and open the plantar fascia down to bone. Assemble and place the Entry Tool through the incision to bone.

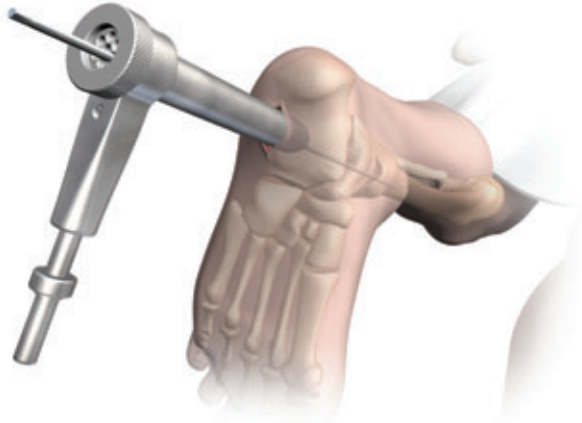

3.2mm x 343mm
Brad Point Tip
Threaded Guide Pin
Cat. no. 7167-4130



Entry Tool
Cat. no. 7163-1114

Guide pin placement

With the hindfoot in the position of desired fusion, the Guide Pin is powered in from the calcaneus to the tibia under fluoroscopic control. The C-arm is rotated into the AP/PA position to verify that the Guide Pin is positioned centrally within the tibia. If initial guide pin placement is not optimal, a second guide pin may be placed through the Entry Tool to ensure proper alignment.



Note: Any deviation from a central position can affect the final fusion position. With the Guide Pin along the anterior tibia, the nail will increase dorsiflexion and anterior position of the foot. However, along the posterior cortex, the Guide Pin will have the opposite effect. The Guide Pin contact with the medial or lateral walls of the tibia can cause increased varus or valgus position changes respectively in the foot.

Once the desired position is confirmed, advance the Guide Pin until it is 2-3cm proximal to the tibiotalar joint.



3.2mm x 343mm
Brad Point Tip
Threaded Guide Pin
Cat. no. 7167-4130

Entry Tool
Cat. no. 7163-1114

Entry reaming

Using the 12.5mm Entry Reamer, ream into the tibia, ideally stopping at the threads on the Guide Pin. This should ensure adequate reaming of the calcaneus, talus, and tibia to accommodate the distal, driving end of the nail.

Note: After canal reaming the Guide Pin will most likely be extracted with removal of the Entry Reamer.

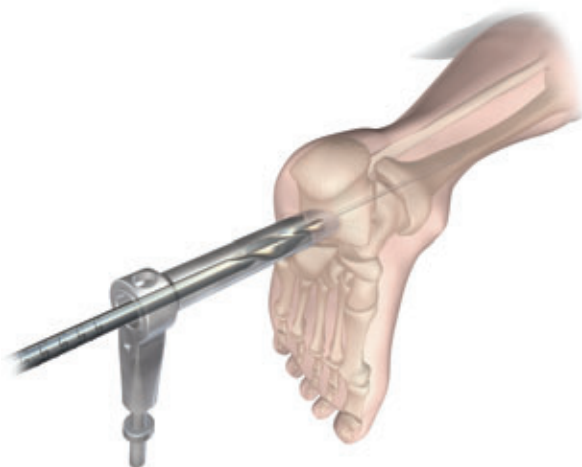

3.2mm x 343mm
Brad Point Tip
Threaded Guide Pin
Cat. no. 7167-4130



Entry Tool
Cat. no. 7163-1114

Reducing the hindfoot anatomy

In most cases, the 3.0mm x 600mm Ball Tip Guide Rod can now be easily inserted through the initial portal made by the Entry Reamer and placed into the center of the tibia. If needed, the hindfoot position can be realigned using the Reducer attached to the T-Handle. Check to ensure the Guide Pin has been removed prior to inserting the Reducer. The Reducer is used to accurately place the Guide Rod in the tibia to assure proper reaming and nail insertion.









To maintain reduction, introduce the Guide Rod through the T-Handle and Reducer with the use of the Gripper. Once the Guide Rod is in place, remove the Reducer, using the Obturator as needed to ensure the Guide Rod stays in place.



Canal reaming

Additional reaming depth may be required. Prepare canal using sequential reamers until canal is 1 – 1.5mm larger than selected nail size.



					
3.0mm x 600mm Ball Tip Guide Rod Cat. no. 7166-5026	Reducer Cat. no. 7175-1105	Gripper Cat. No. 7163-1100	Obturator Cat. No. 7163-1122	Reamer Heads Cat. No. 7111-823X	Flexible Shaft Cat. No. 7111-8200

Nail assembly and insertion

Assemble the nail to the Drill Guide using the Guide Bolt and Guide Bolt Wrench. The nail is keyed and can only be assembled to the Drill Guide in the correct way.

Attach the Drop (7170-0004) to the drill guide and verify targeting accuracy by inserting a gold 9.0mm Drill Sleeve (7163-1152) and silver 4.0mm Drill Sleeve (7167-4083) into the Drop and passing a 4.0mm Long Pilot Drill (7163-1110) through the assembly. An incorrectly attached nail will not target.

Using hand force, insert the nail through the incision into the reamed canal and seat flush to the plantar surface of the calcaneus.

Note: Once proper entry depth is obtained, the Impactor may be attached to the Drill Guide. Initial manual compression may be achieved by flexing the knee and using the Slotted Hammer to tap the construct.

Position the C-arm to obtain an M-L view of the nail's driving end. Maintain the foot in the anatomical position and rotate the nail until the transverse hole can be visualized as a perfect circle. Under fluoroscopy, use the shadows of the cuboid and talus screw holes as alignment guides for screw placement.

Once proper alignment is established, the orientation can be fixed using a guide pin(s) through the provisional fixation holes in the Drill Guide.

Remove the Guide Rod prior to fully seating the nail.

Note: The Guide Rod will not pass through the Impactor.

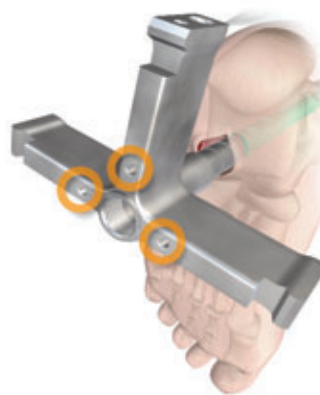
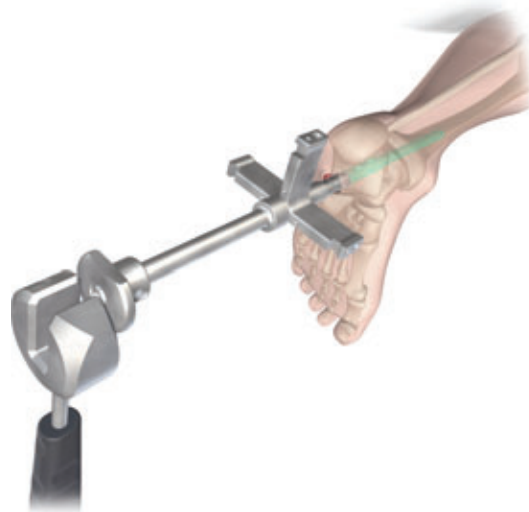

Screw insertion

Although screw placement sequence is at the surgeon's discretion, it is recommended that the locking screws be placed sequentially from calcaneus to tibia to allow impaction at each joint level.

Attach the Drop to the posterior side of the Drill Guide. Place the 4.0mm Silver Inner Drill Sleeve into the Gold Outer Drill Sleeve and insert the sleeve assembly through the Drop's cuboid hole. The sleeve assembly end should sit on the lateral side of the calcaneal tuberosity and not on the lateral face of the calcaneus. Rotate the nail assembly if needed to keep the screws on the posterior surface. Make a stab incision to allow the sleeves to contact bone.

Note: For added stability and rotational control, advance the Long Pilot Drill through the drill sleeve assembly to the desired depth. Remove the Long Pilot Drill from power, leaving it in the cuboid hole as a provisional fixation tool for the talus screw insertion.

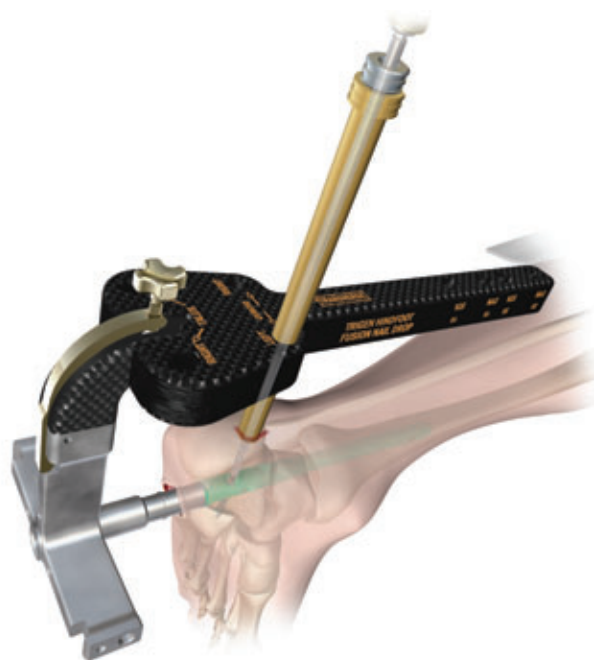

Drop
Cat. No. 7170-0004



4.0mm Silver Inner
Drill Sleeve
Cat. No. 7167-4083



9mm Gold Outer
Drill Sleeve
Cat. No. 7163-1152

Talus screw insertion

Screw length is determined from the calibrated markings on the Long Pilot Drill or by using the Screw Depth Gauge.

The talus screw should be inserted from posterior-inferior and lateral in the calcaneus to anterior-medial in the talar dome. This screw will sit approximately perpendicular to the subtalar joint.

Advance the Long Pilot Drill. Remove the Long Pilot Drill and the Silver Inner Drill Sleeve. Attach the 5.0mm screw to the Medium Hex Driver. Attach the Medium Hex Driver to power or use the manual T-Handle to insert the screw. Insert the screw assembly through the Gold Outer Drill Sleeve.

When using power, stop advancing the screw when the laser marked ring on the Medium Hex Driver approaches the top of the Gold Outer Drill Sleeve. It is recommended that final tightening of the screw should always be under manual control.

Note: Sinking the distal screw heads into the calcaneus helps prevent soft tissue irritation.

The Screw Driver Release Handle may be used to detach the Medium Hex Driver from the screw. Once the talus screw is placed, the tibiotalar joint can be manually compressed and aligned by attaching the Impactor to the Drill Guide and using the Slotted Hammer to tap the construct.

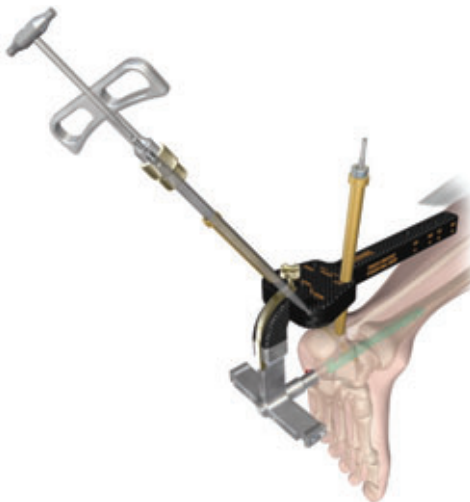
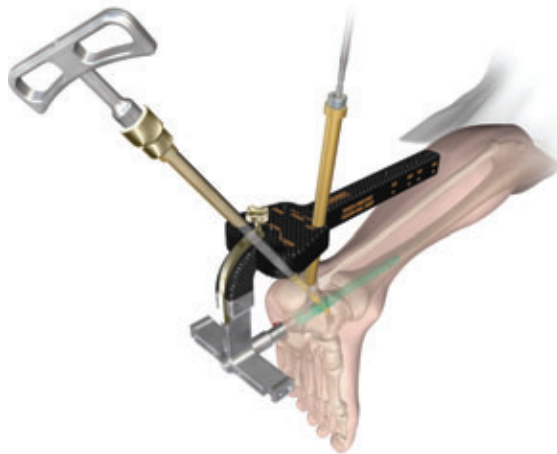
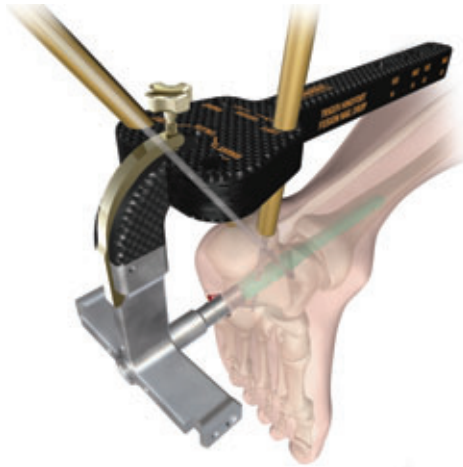

4.0mm Long Pilot Drill
Cat. No. 7163-1110

Screw Depth Gauge
Cat. No. 7163-1189

5.0mm Internal Hex Captured Locking Screw
Cat. No. 7164-22XX

Medium Hex Driver
Cat. No. 7163-1066

Screw Driver Release Handle
Cat. No. 7163-1208

T-Handle
Cat. No. 7163-1172

Cuboid screw insertion

Repeat this procedure for the cuboid screw which should be oriented posterior-medial in the calcaneus to anterior-lateral in the cuboid.

Advance the Long Pilot Drill through to the anterior process of the calcaneus. If cuboid fixation is desired, continue advancing the Long Pilot Drill through to the distal aspect of the cuboid.

Transverse screw insertion

Once these screws are in place, a third transverse distal locking option can be used at the surgeon's discretion.

Remove the Drop and attach it on the lateral aspect of the Drill Guide. Markings on the Drill Guide will help ensure proper orientation.

Insert the drill sleeve assembly into the transverse hole on the Drop and repeat the above procedure.

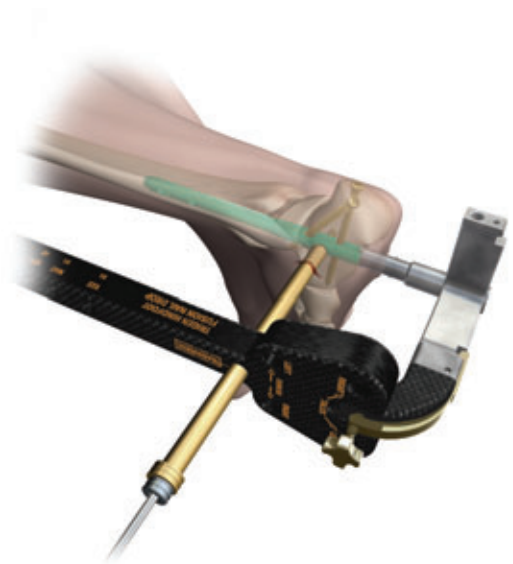

4.0mm Long
Pilot Drill
Cat. No. 7163-1110

Screw Depth Gauge
Cat. No. 7163-1189



5.0mm Internal Hex
Captured Locking
Screw
Cat. No. 7164-22XX



Medium Hex Driver
Cat. No. 7163-1066



Screw Driver
Release Handle
Cat. No. 7163-1208



T-Handle
Cat. No. 7163-1172

Proximal locking screw insertion

To lock the nail proximally, remove the Drop and attach it on the medial aspect of the Drill Guide. Markings on the Drill Guide will help ensure proper Drop orientation.

Dynamic or static proximal locking options are available to the surgeon. Both options provide a locking screw to prevent rotation of the implant. The dynamic option allows for up to 5mm of late settling of the nail. If this option is chosen it is important to ream beyond the desired nail length to minimize binding. Markings on the Drop dictate the proximal static or dynamic locking options available.

Note: The 25cm nail can not be targeted proximally and must be done freehand. The same screw drilling and insertion procedure used distally is then repeated.

When presented with hard cortical bone, the 4.7mm Diaphyseal Starter Drill can be used to perforate the near cortex.

Note: The Silver Inner Drill Sleeve must be removed from the Gold Outer Sleeve prior to using the Diaphyseal Drill. The Gold Outer Drill Sleeve must be touching bone as the Diaphyseal Drill will bottom out on the Gold Outer Drill Sleeve.

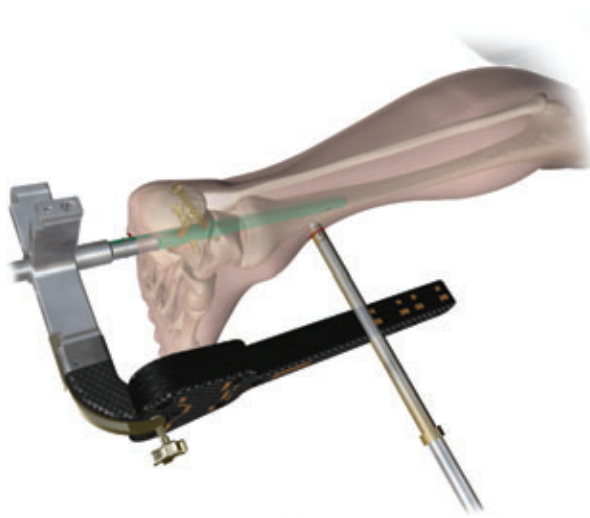

4.7mm Diaphyseal
Starter Drill
Cat. no. 7170-0006

Implantation complete

Note: Bone graft or bone graft substitutes should be used to fill in gaps around the bones to enhance bony union.

Follow standardized procedures for closure.

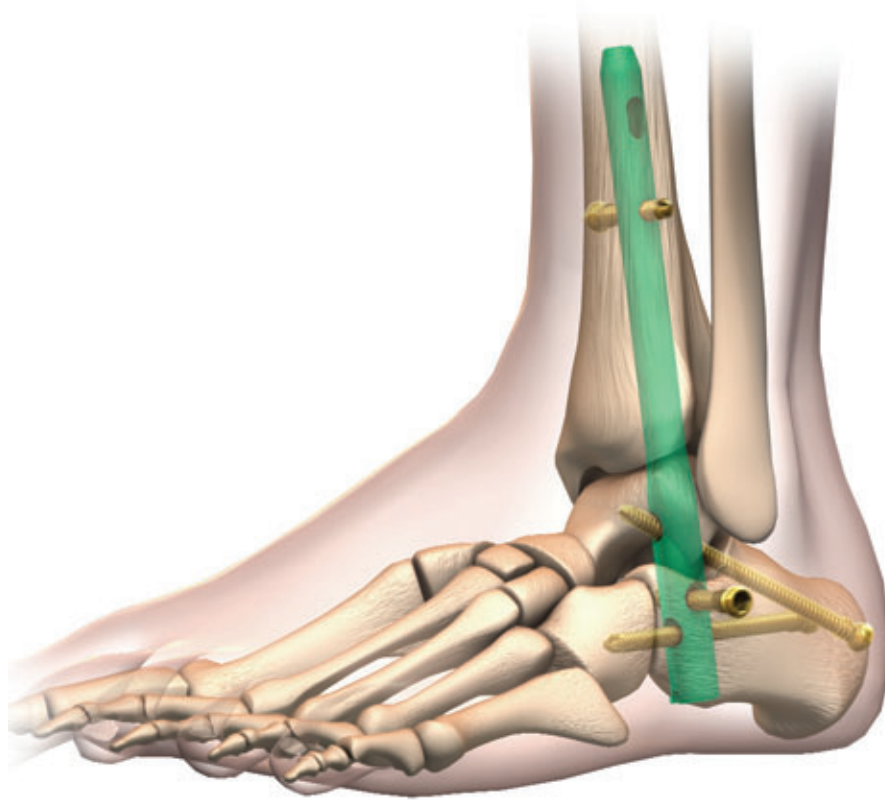

Nail removal

It is not recommended to remove the nail unless deep infection occurs or if the patient is symptomatic.

However if removal is required, then dissect the plantar soft tissue to expose the distal end of the nail. Clear away any tissue or bone that may have grown into the threads in the end of the nail. Thread the Large Nail Extractor tool into the distal end of the nail before screw removal to restrict nail movement. The Impactor may also be threaded into the Large Nail Extractor to aid in the nail extraction.

Make stab wounds over the original incisions and remove the screws with the Medium Hex Driver and T-Handle.

Once all the screws have been removed, extract the nail from the foot. The Slotted Hammer may be used with the Impactor to aid in removal.

Close in the usual manner.

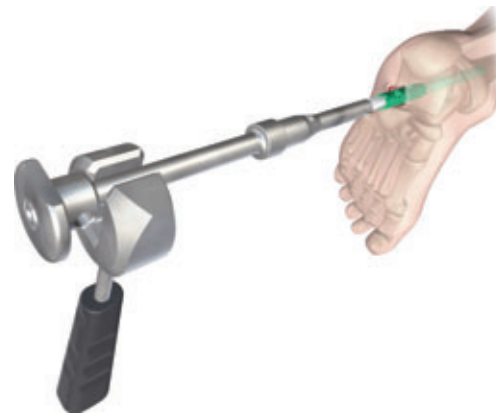
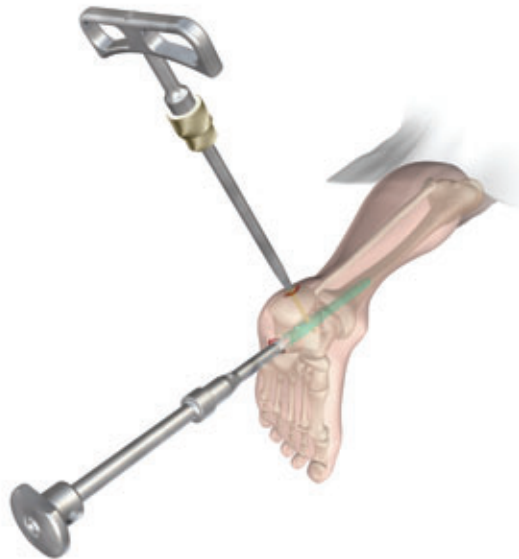
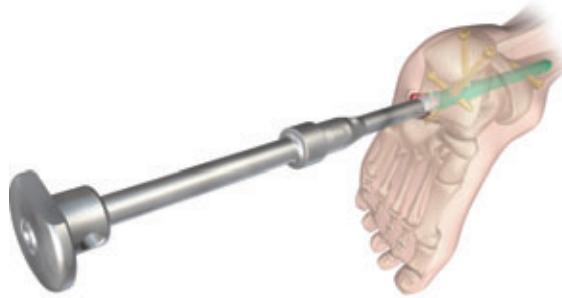

Large Nail Extractor
Cat. no. 7163-1278

Catalog information – Implants (Set No. 7170-0000)

5.0mm Internal Hex Captured Locking Screws

Cat. No.	Length
7164-2225	25mm
7164-2230	30mm
7164-2235	35mm
7164-2240	40mm
7164-2245	45mm
7164-2250	50mm
7164-2255	55mm
7164-2260	60mm
7164-2265	65mm
7164-2270	70mm
7164-2275	75mm
7164-2280	80mm
7164-2285	85mm
7164-2290	90mm
7164-2295	95mm
7164-2200	100mm
7164-2205	105mm
7164-2210	110mm



TRIGEN® Hindfoot Fusion Nails – 10mm

Cat. No.	Description
7170-1016L	10mm x 16cm Left
7170-1016R	10mm x 16cm Right
7170-1020L	10mm x 20cm Left
7170-1020R	10mm x 20cm Right
7170-1025L	10mm x 25cm Left
7170-1025R	10mm x 25cm Right



TRIGEN Hindfoot Fusion Nails – 11.5mm

Cat. No.	Description
7170-1116L	11.5mm x 16cm Left
7170-1116R	11.5mm x 16cm Right
7170-1120L	11.5mm x 20cm Left
7170-1120R	11.5mm x 20cm Right
7170-1125L	11.5mm x 25cm Left
7170-1125R	11.5mm x 25cm Right



Catalog information – Instruments (Set No. 7170-0001)

Screw Length Sleeve

Cat. No. 110238



SCULPTOR Flexible Shaft with Circular Connector

Cat. No. 7111-8200



Medium TRIGEN® Hexdriver

Cat. No. 7163-1066



Short TRIGEN Hexdriver

Cat. No. 7163-1068



Gripper

Cat. No. 7163-1100



Entry Tool

Cat. No. 7163-1114



12.5mm Entry Reamer

Cat. No. 7163-1116



Obturator

Cat. No. 7163-1122



Guide Bolt

Cat. No. 7163-1136



Guide Bolt Wrench

Cat. No. 7163-1140



Catalog information – Instruments (Set No. 7170-0001)

Hammer

Cat. No. 7163-1150



9mm Gold Outer Drill Sleeve

Cat. No. 7163-1152



4.0mm Silver Inner Drill Sleeve

Cat. No. 7167-4083



T-Handle (Zimmer-Hall)

Cat. No. 7163-1172



Mini Connector

Cat. No. 7163-1186



Mini Connector with Trinkle End

Cat. No. 7163-1187



Screw Depth Gauge

Cat. No. 7163-1189



Screw Driver Release Handle

Cat. No. 7163-1208



Large Nail Extractor

Cat. No. 7163-1278



Cannulated Impactor

Cat. No. 7167-5081



Catalog information – Instruments (Set No. 7170-0001)

TRIGEN® Hindfoot Fusion Nail Drop

Cat. No. 7170-0004



TRIGEN Hindfoot Fusion Nail Drill Guide

Cat. No. 7170-0005



TRIGEN 4.7mm Diaphyseal Starter Drill

Cat. No. 7170-0006



Straight Reducer 4.2mm ID/6.6mm OD

Cat. No. 7175-1105



AO Mini Connector

Cat. No. 7175-1153



Modular Reamer Box Kit

Cat. No. 7163-1218



Reamer Heads

Cat No.	Description
71118231	9.0mm Endcutting
71118233	9.5mm Pilot Nose
71118234	10.0mm Pilot Nose
71118235	10.5mm Pilot Nose
71118236	11.0mm Pilot Nose
71118237	11.5mm Pilot Nose
71118238	12.0mm Pilot Nose



Large Outer Case – 4.8”

Cat. No. 7112-9400



Lid for Outer Case

Cat. No. 7112-9402



TRIGEN® Hindfoot Fusion Nail Top Instrument Tray
(Not shown)
Cat. No. 7170-0015

TRIGEN Hindfoot Fusion Nail Bottom Instrument Tray
(Not shown)
Cat. No. 7170-0016

Catalog information – Disposables (Set No. 7170-0012)

4.0mm Long Pilot Drill
Cat. No. 7163-1110



4.0mm Short Drill
Cat. No. 7163-1117



3.0mm x 600mm Ball Tip Guide Rod
Cat. No. 7166-5026



3.2mm x 343mm Brad Tip Threaded Guide Pin
Cat. No. 7167-4130



Catalog information – Samples (Set No. 7170-0013)

TRIGEN Hindfoot Fusion Nail Sample Nail
10mm x 16cm Left
Cat. No. 7119-1016L



Internal Hex Locking Screw 5.0mm x 35mm
Cat. No. 7119-2535



Internal Hex Locking Screw 5.0mm x 70mm
Cat. No. 7119-2570



TRIGEN Hindfoot Fusion Nail Sample Case
(Not shown)
Cat. No. 7170-0014

Orthopaedics

Smith & Nephew, Inc.
1450 Brooks Road
Memphis, TN 38116
USA

www.smith-nephew.com

Telephone: 1-901-396-2121
Information: 1-800-821-5700
Orders/Inquiries: 1-800-238-7538